

Porte Isotherme Coulissante SP400 / SP410 / SP420

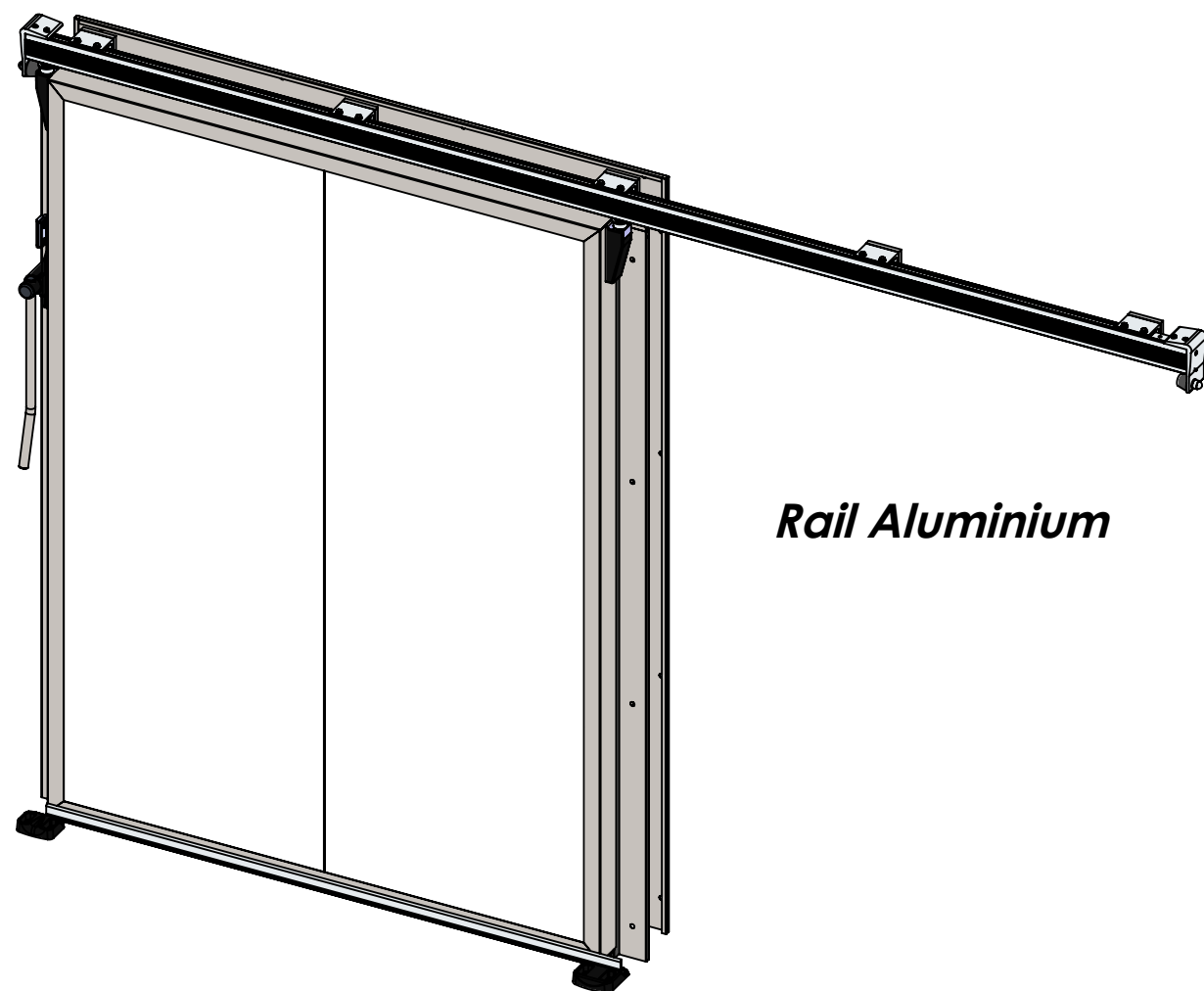

Rail Aluminium

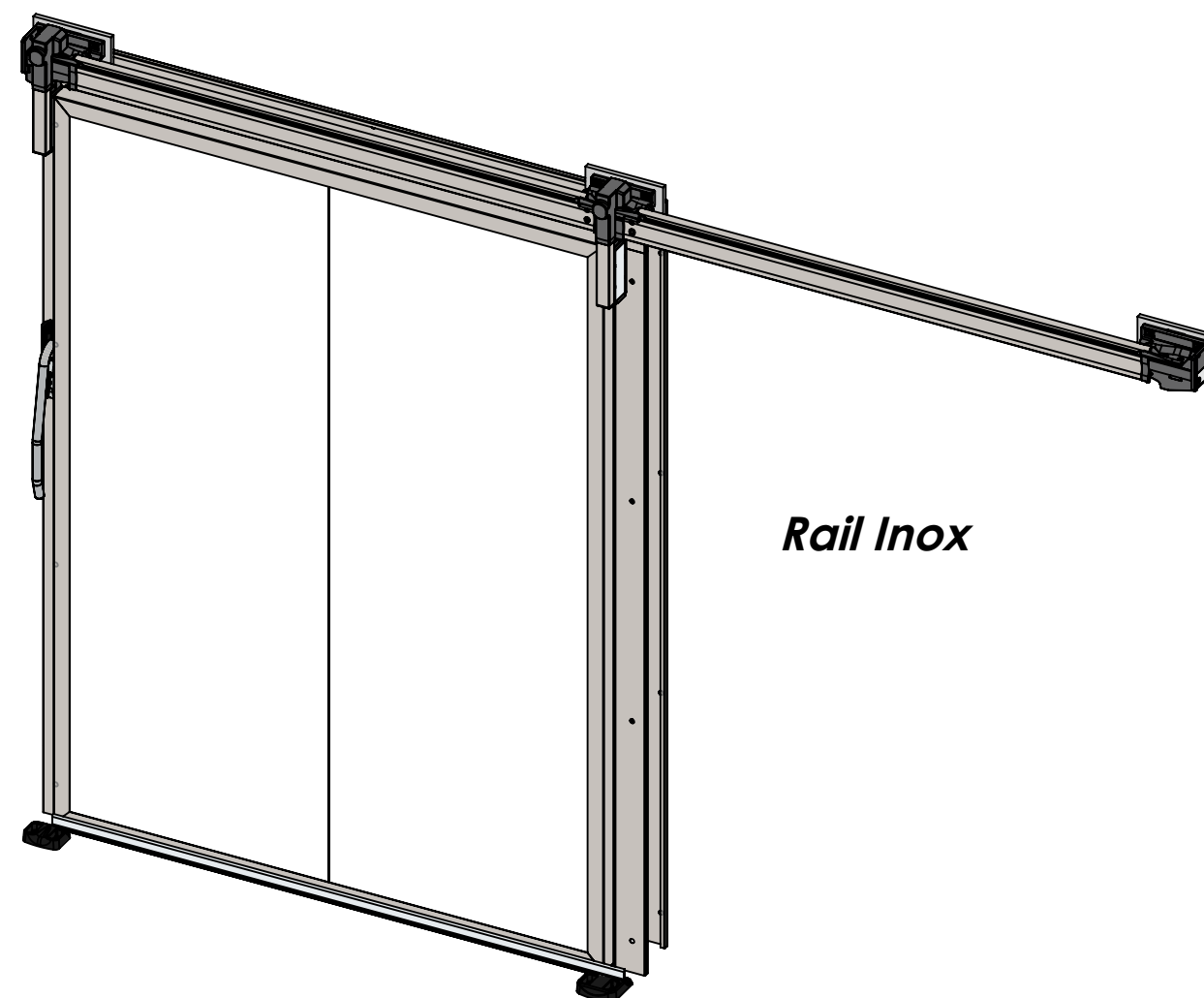

Rail Inox

Vantail en :

- Tôle acier prélaquée (SP400)
- Polyester armé de fibres de verre (SP410)
- Inox 304L (ou 316L) finition brossée (SP420)

Type Porte :

SP400
SP410
SP420

Vantail
Rebordé Inox
Huisserie Inox

SPENLE 

F-57400 SARREBOURG
+33 (0)3 87 25 78 00
www.spenle.fr
info@spenle.fr

Vue Extérieure Côté Rail

Vue Intérieure

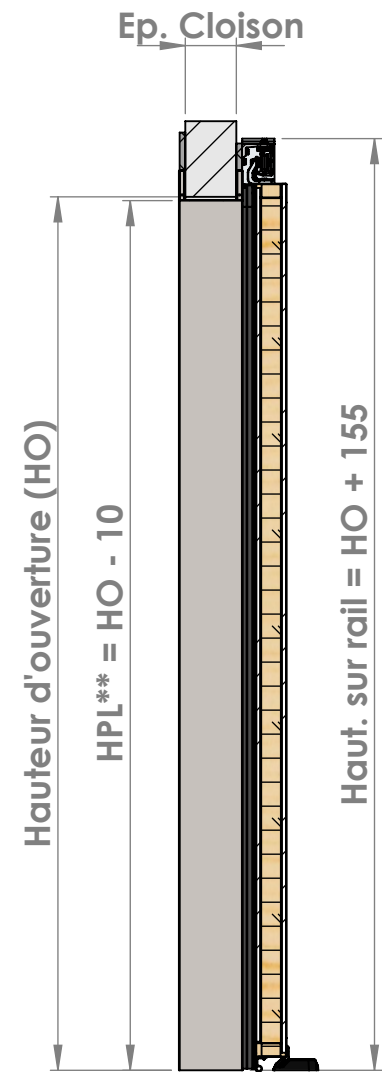
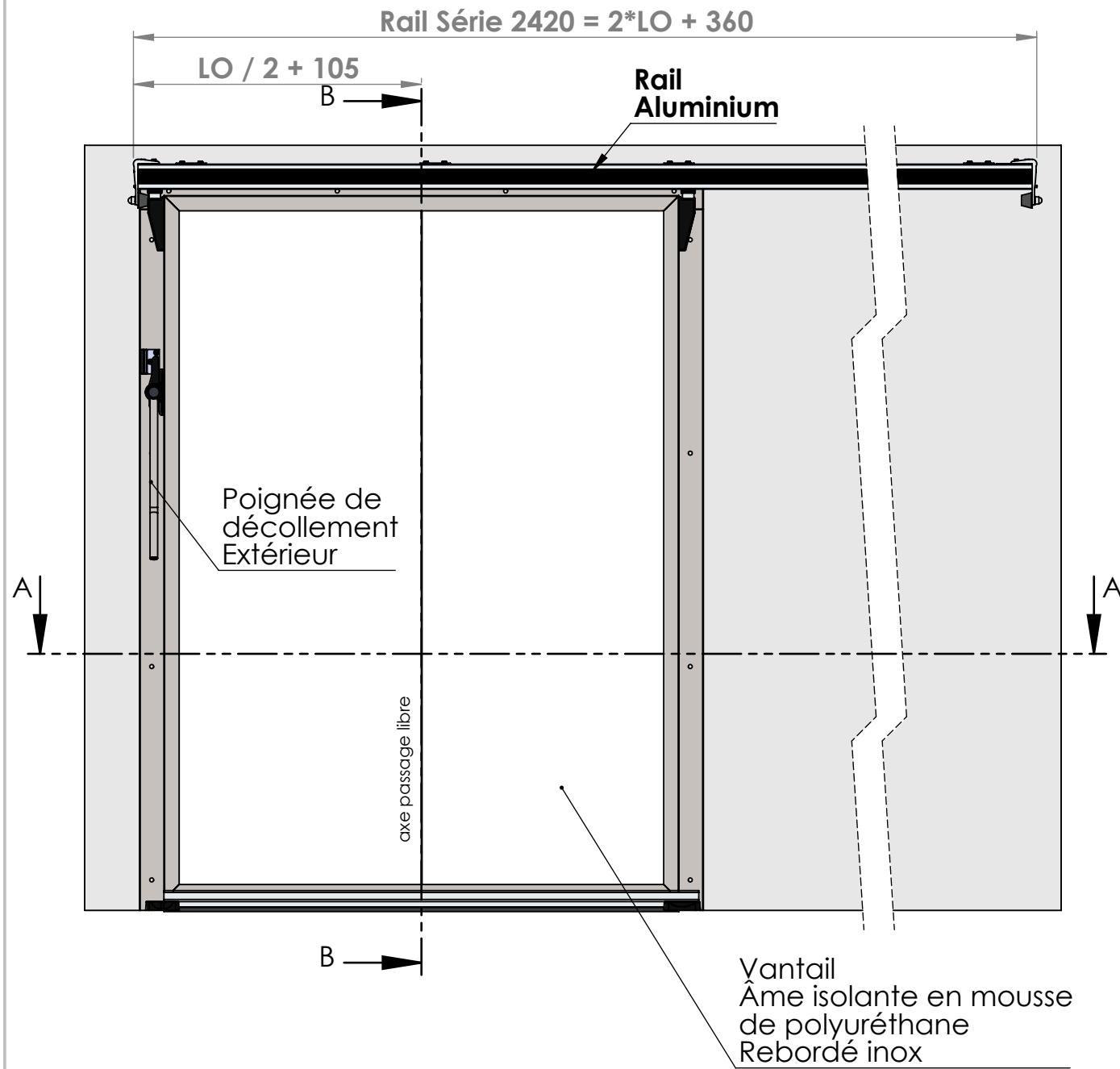

COUPE B-B

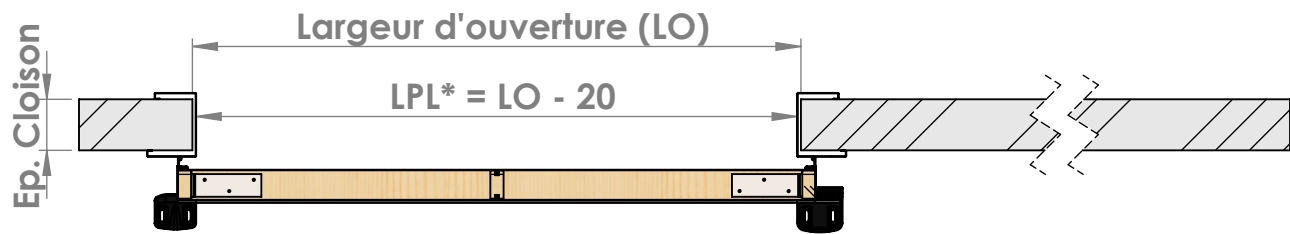
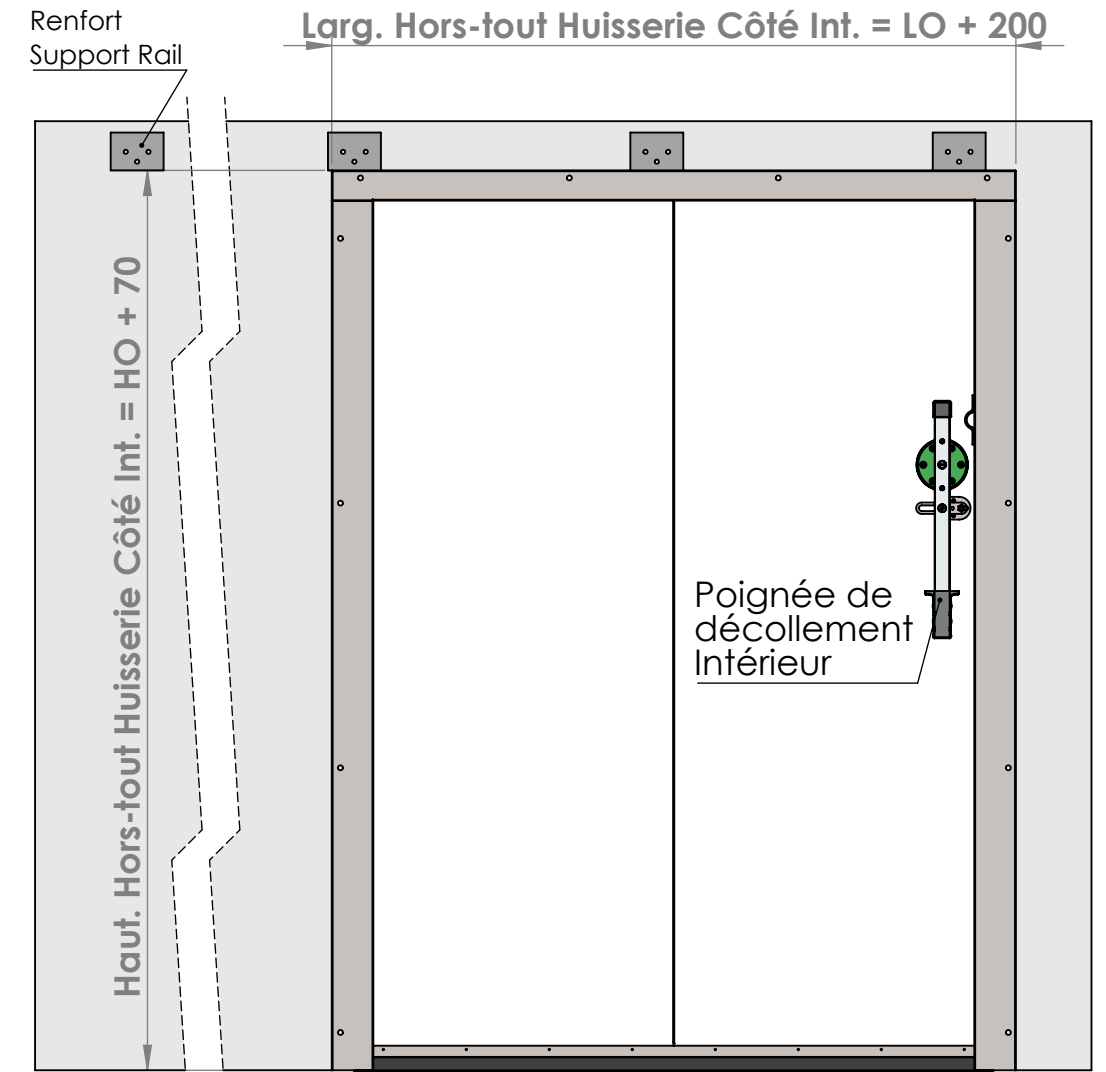

COUPE A-A

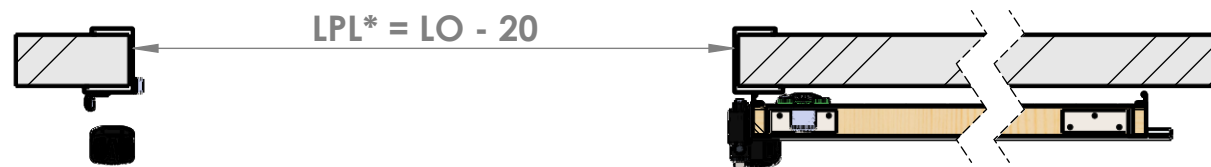
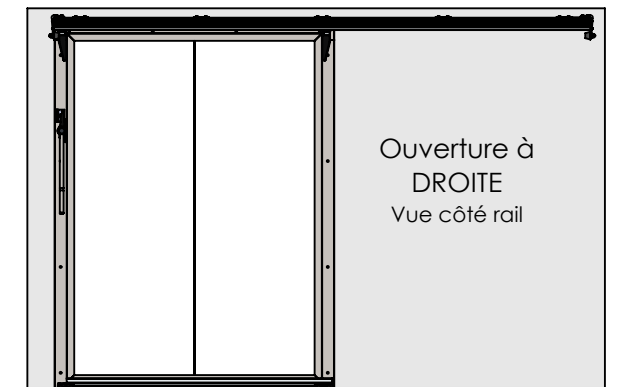

*LPL : Largeur Passage Libre
 **HPL : Hauteur Passage Libre

Type Porte :
SP400
SP410
SP420
Rail Alu

Vantail
 Rebordé Inox
 Huisserie Inox en C



F-57400 SARREBOURG
 +33 (0)3 87 25 78 00
 www.spenle.fr
 info@spenle.fr

Vue Extérieure Côté Rail

Vue Intérieure

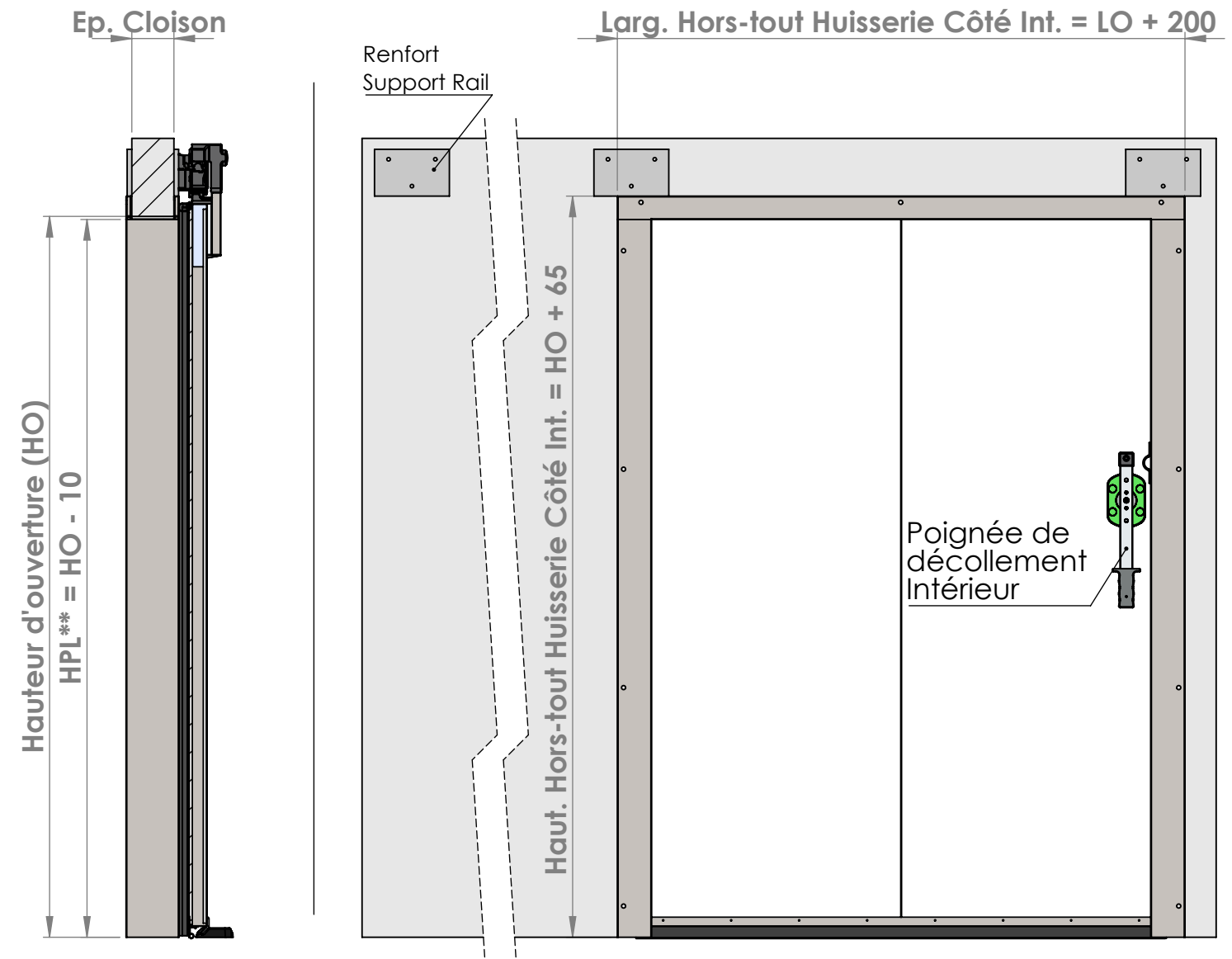
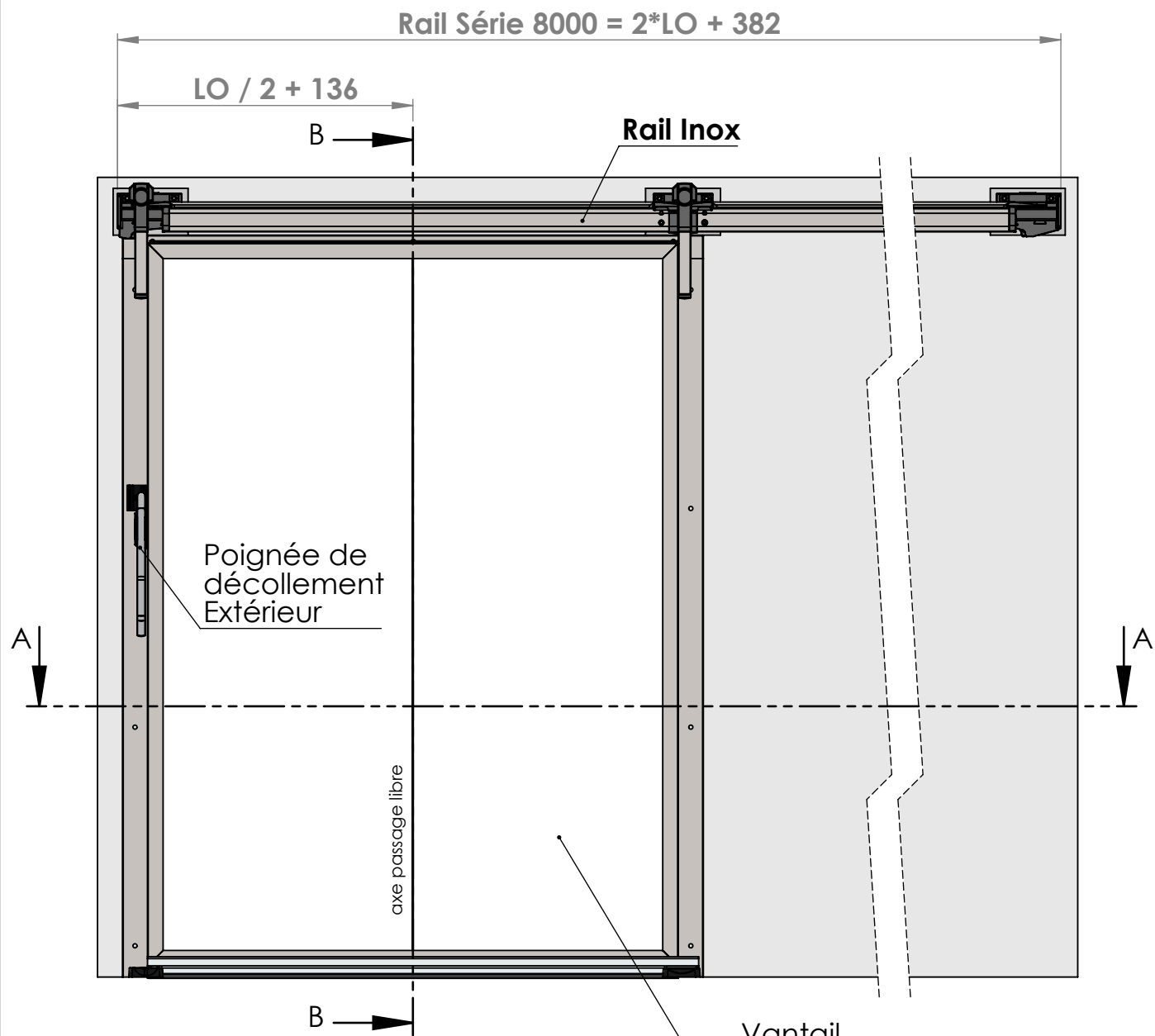

COUPE B-B

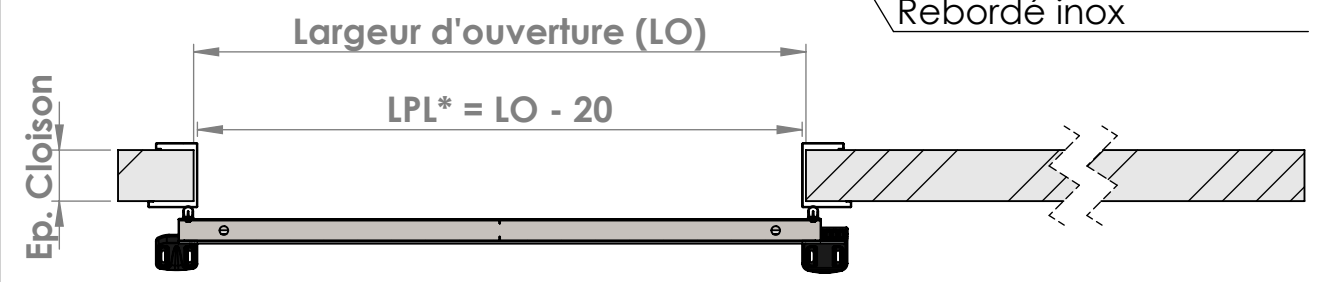

COUPE A-A

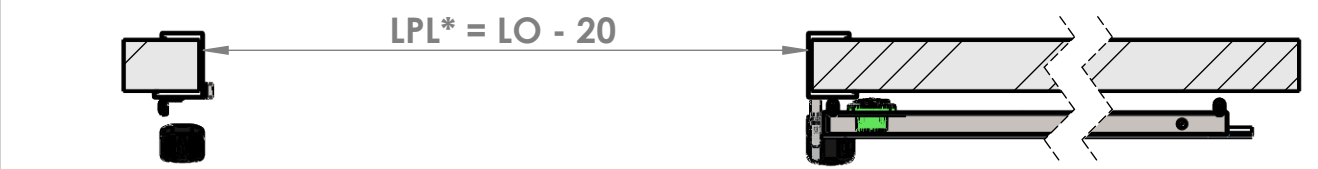
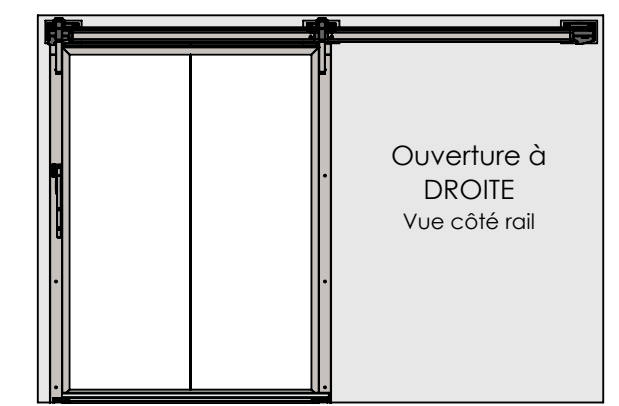
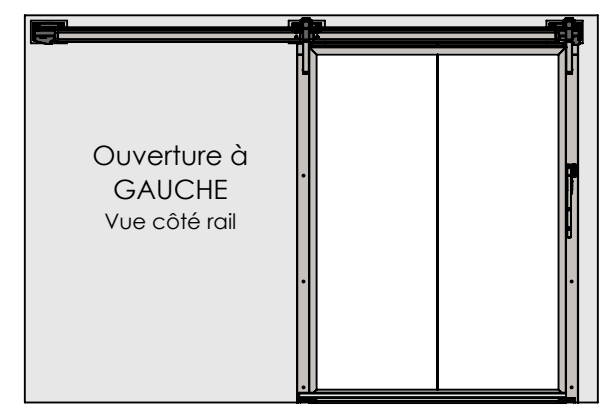

Porte Ouverte

*LPL : Largeur Passage Libre
 **HPL : Hauteur Passage Libre

Type Porte :
SP400
SP410
SP420
Rail INOX

Vantail
Rebordé Inox
Huisserie Inox en C

SPENLE 
 F-57400 SARREBOURG
 +33 (0)3 87 25 78 00
 www.spenle.fr
 info@spenle.fr

Détails Huisseries C / L

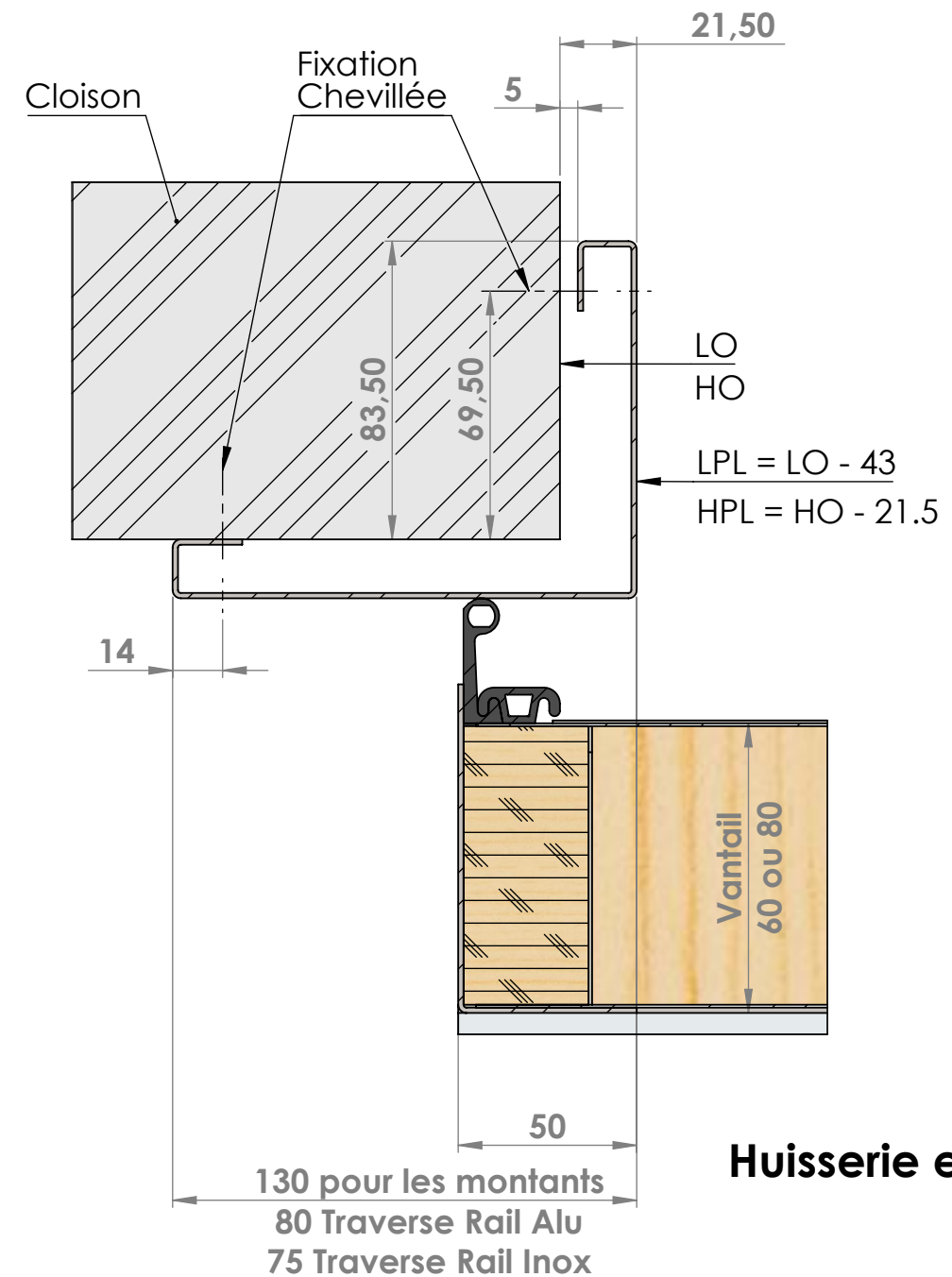
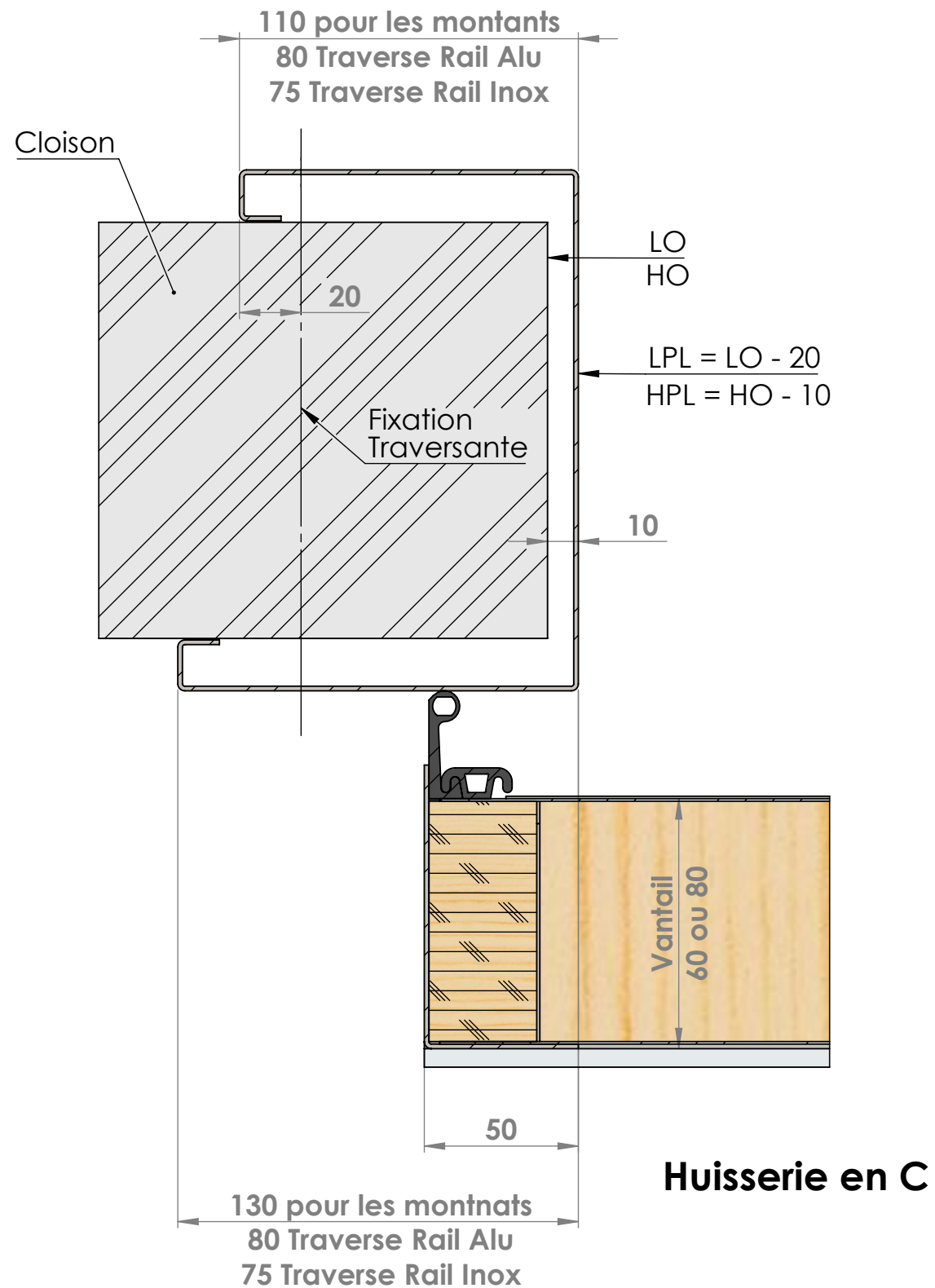

LO : Largeur d'ouverture
HO : Hauteur d'ouverture
LPL : Largeur Passage Libre
HPL : Hauteur Passage Libre

Type Porte :

SP400
SP410
SP420

Vantail
Rebordé Inox
Huisserie Inox

SPENLE 

F-57400 SARREBOURG
+33 (0)3 87 25 78 00
www.spenle.fr
info@spenle.fr